

# robot coupe<sup>®</sup>



**POWER MIXERS**



**RESTAURANTS - CATERERS - DELICATESSENS**

## COMPACT

### MINI

#### ▶ Mini MP



MicroMix

Mini MP 160 V.V.  
Mini MP 190 V.V.  
Mini MP 240 V.V.

For handling smaller quantities

2000 to 12500 rpm

#### ▶ CMP



CMP 250 V.V. CMP 300 V.V. CMP 350 V.V.

15 litres 30 litres 45 litres

2300 to 9600 rpm

#### ▶ MP Ultra STAINLESS STEEL MOTOR BASE

New, even more ergonomic handle design



MP 350 Ultra MP 450 Ultra MP 550 Ultra MP 600 Ultra

50 litres 100 litres 200 litres 300 litres

MP 350/MP 450 : 9500 rpm  
MP 350 V.V./MP 450 V.V. : 1500 to 9000 rpm

9000 rpm

9500 rpm

▶ Special for emulsions

▶ For handling smaller quantities

▶ Special catering models Up to 45 litres

▶ Specially designed / commercial catering

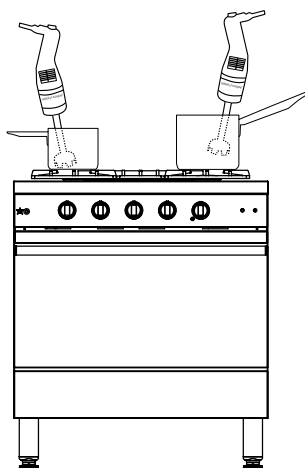

MicroMix Mini MP

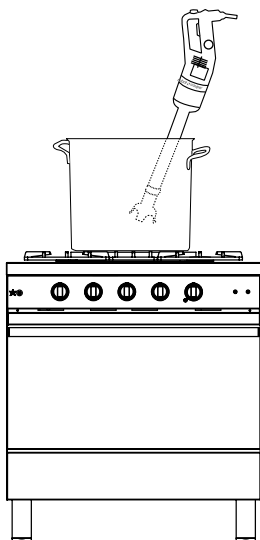

CMP

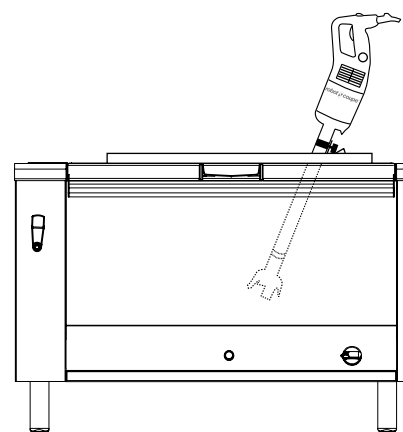

MP Ultra

# COMBI

▶ Mini MP - CMP - MP Ultra - MP FW Ultra

STAINLESS STEEL MOTOR BASE

New, even more ergonomic handle design

**1000 W**



600 mm

740 mm

MP 800 Turbo

**400 litres**

9500 rpm

**250 W**



190 mm

**270 W**



185 mm

240 mm

Mini MP 190 Combi

Mini MP 240 Combi

**For handling smaller quantities**

Mixer : 2000 to 12500 rpm  
Whisk : 350 to 1560 rpm

**310 W**



250 mm

**350 W**



220 mm

300 mm

CMP 250 Combi

CMP 300 Combi

**15 litres**

**30 litres**

Mixer : 2300 to 9600 rpm  
Whisk : 500 to 1800 rpm

**440 W**



350 mm

**500 W**



280 mm

450 mm

MP 350 Combi Ultra

MP 450 Combi Ultra

**50 litres**

**100 litres**

Mixer : 1500 to 9000 rpm  
Whisk : 250 to 1500 rpm

**500 W**



MP 450 FW Ultra

**100 litres**

250 to 1500 rpm



# ▶ MINI Range



## ▶ Mixer



## ▶ Emulsify



## ▶ Beat

**FOR HANDLING SMALLER QUANTITIES**

### COMBI



Mini MP  
160 V.V.

Mini MP  
190 V.V.

Mini MP  
240 V.V.

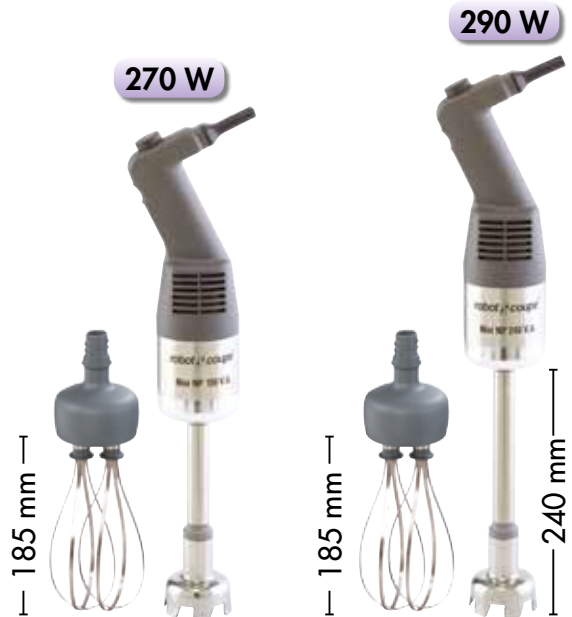

Mini MP  
190 Combi

Mini MP  
240 Combi

2000 to  
12500 rpm

**Mixer:** 2000 to 12500 rpm  
**Whisk:** 350 to 1560 rpm

## ▶ MINI Range

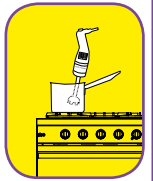

# FOR HANDLING SMALLER QUANTITIES

### ERGONOMIC



**Shape of the handle** specifically designed to ensure a **good grip** and manipulation of the Power Mixer, thus **reducing user fatigue**.

### VARIABLE SPEED

- 2000 to 12500 rpm in mixer function
- 350 to 1500 rpm in whisk function



### POWER



A powerful motor (220-270 W according to model) for an even longer lifespan!

### HYGIENE



**Detachable tube and blade assembly** for perfect hygiene, with a patented system exclusive to Robot-Coupe. **Tube, bell and blade assembly all made from stainless steel** for

a longer lifespan.

The Mini MP 190 V.V. and Mini MP 240 V.V. models have a detachable bell.

### MULTIPURPOSE



**Overmoulded stainless-steel blades** ensuring perfect hygiene and ideal for making coulis, cream soups and sauces.



**Detachable stainless-steel emulsifying disc** for aerating hot and cold sauces and giving them a foamy consistency.

### Mini MP Combi

### STURDINESS

**Whisk housing** with all-metal interior for greater resilience.



FOR THE BEST PRICE CONTACT  
**WHOLESALES**  
VISIT: [WWW.ONESTOPWHOLESALES.COM](http://WWW.ONESTOPWHOLESALES.COM)  
1300 131 700

## ▶ COMPACT Range



### ▶ Mixer



### ▶ Beat

SPECIALLY DESIGNED FOR THE CATERING SECTOR

COMBI



2300 to 9600 rpm

**Mixer:** 2300 to 9600 rpm  
**Whisk:** 500 to 1800 rpm

FOR THE BEST PRICE CONTACT  
**WHOLESALE**  
PHONE: 1300 131 700  
VISIT: WWW.ONESTOPWHOLESALE.COM

## ▶ COMPACT Range

# SPECIAL CATERING MODELS UP TO 45 LITRES

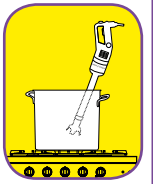

### ERGONOMIC



**Compact, lightweight appliance that is easy to handle**

### COMFORT



**Variable speed function providing the greater flexibility required for sophisticated preparations.**

### POWER



**More powerful motor: + 15% for even more efficient machine.**

### HYGIENE



**Removable stainless steel blade and bell for easy cleaning and maintenance.**

### PERFORMANCE



**The CMP Combi models (mixer+whisk) also boast a new 100% stainless-steel bell**



**Optimum blending quality giving the finished product a fine texture within a minimum of time.**



### CMP Combi

### STURDINESS

- **Whisk housing with all-metal interior for greater resilience.**
- **Overmoulded whisks ensuring perfect hygiene.**

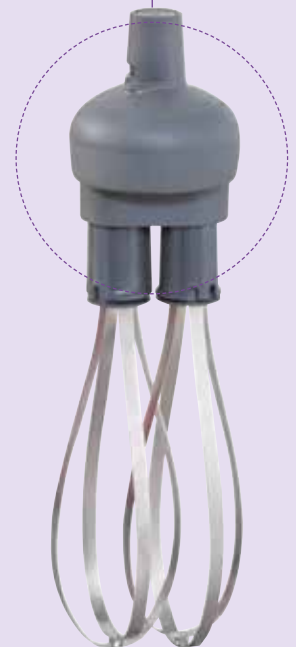

FOR THE BEST PRICE CONTACT  
**WHOLESALES**  
PHONE: 1300 131 700 VISIT: WWW.ONESTOPWHOLESALES.COM

# ▶ LARGE Range



## ▶ Mixer

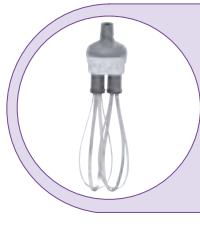

## ▶ Beat

SPECIALLY DESIGNED / COMMERCIAL CATERING

New, even more ergonomic handle design

1000 W

850 W

750 W

500 W

440 W

COMBI

500 W

440 W

500 W

MP 350 Ultra    MP 450 Ultra    MP 550 Ultra    MP 600 Ultra    MP 800 Turbo

MP 350 Combi Ultra    MP 450 Combi Ultra    MP 450 FW Ultra

**MP 350/MP 450:**  
9500 rpm  
**MP 350 V.V./MP 450 V.V.:**  
1500 to 9000 rpm

9000 rpm

9500 rpm

9500 rpm

**Mixer :** 1500 to 9000 rpm  
**Whisk :** 250 to 1500 rpm

250 to 1500 rpm

WHOLESALE FOR THE BEST PRICE CONTACT VISIT: WWW.ONESTOPWHOLESALE.COM



# ▶ LARGE Range

## SPECIALLY DESIGNED / COMMERCIAL CATERING

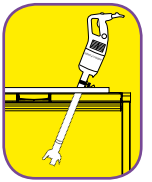

### COMFORT



The V.V. and Combi models now have an **even more ergonomic variable speed button** for greater user comfort.

### DURABILITY



Sturdy construction thanks to its **stainless steel motor base**.

### HYGIENE



**Removable stainless steel blade and bell** for easy cleaning and maintenance.

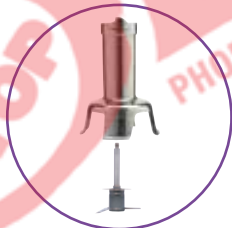

### PERFORMANCE



More powerful motor :  
+ 20% for even more efficient machine.  
Increased performance for **optimized mixing time**.



STAINLESS  
STEEL

STAINLESS  
STEEL

STAINLESS  
STEEL

### MP Combi

### METAL GEAR BOX



• **Overmoulded whisks** ensuring perfect hygiene.

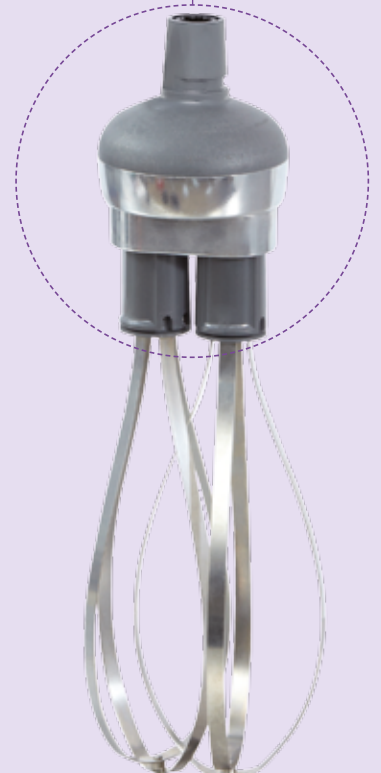

## ▶ PAN SUPPORTS MP/CMP

These 100% stainless-steel pan supports allow you to effortlessly tilt the mixer or simply leave it to its own devices. They can be totally dismantled, making them easy to clean and extremely practical to use.

### Adjustable pan supports



Three pan supports available as optional extras.

They adapt to the size of the pan:

- Pan diameter 330-650 mm
- Pan diameter 500-1000 mm
- Pan diameter 850-1300 mm

### Universal pan support



For any pans diameter.

## ▶ MIXING TOOL ATTACHMENT

Ergonomic handle

Rubber protection

- **Variable speed** from 150 to 510 rpm
- Total length of the tool : **690 mm**
- Available as an optional extra with the Ultra Combi models.

#### Uses:

potato flakes, dehydrated base for soups etc...



## ▶ FOOD HYGIENE ADVICE CLEANING



Bell and blade removable for ease of cleaning



**HACCP**  
Advice

In line with HACCP advice, the cleaned bell and blade should be stored in a cold room after use

## ▶ LARGE Range

# SPECIALLY DESIGNED / COMMERCIAL CATERING

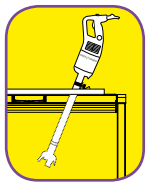

## ERGONOMIC

- **Ergonomic handle** design for greater user comfort.



- **The speed variation button** on the V.V. and Combi models can easily be operated with one hand.



- **The lug on the motor housing** can serve as a rest and pivot on the rim of a pan, making the power mixer easier to handle.



- **New power cord winding system** for tidy storage and optimum lifespan.



## DETACHABLE POWER CORD

- **New patented «Easy Plug» system** making it easier to replace the power cord during after-sales servicing.
- **Indicator light:** Quick detection of power cord failure thanks to the green light. The light is on when the cord is properly plugged on both ends (wall and easy plug) and is working.



## EXCLUSIVE TECHNOLOGY



### THE MAIN BENEFITS

- **Perfect hygiene:** Foot, knife, bell, and whisk fully removable - a Robot-Coupe exclusive.
- **Robust machine:** The design of the machines and the materials used in their construction guarantee a sturdy machine.
- **Large processing capacity:** Powerful motor for fast processing and an optimum quality end-product.
- **Easy maintenance:** All stainless steel tube, bell, knife and whisk.
- **Compact models:** Space saving and easy to use. 5 models to process small quantities.



### PAN CAPACITY

Between 2 and 400 litres according to the model.



### TARGET

Restaurants, Caterers, Delicatessens, Day Nurseries.



### IN BRIEF

The performance in terms of hygiene, ease of use, multiple functions, longer life, and profitability make it the best choice on the market.

We reserve the right to alter at any time without notice the technical specifications of this appliance. None of the information contained in this document is of a contractual nature. Modifications may be made at any time. © All rights reserved for all countries by : ROBOT-COUPÉ s.n.c.



	Electrical data			Dimensions (in mm)				Weight (kg)	
	Variable speed (rpm)	Power (Watts)	Voltage* (Amp.)	A	B	C	D	net	gross
<b>Micromix</b>	1,500 to 14,000	220	230 V/50Hz - 1,1	68	430	61	165	1.07	1.44

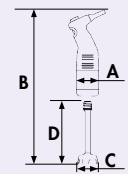

MINI RANGE	Electrical data			Dimensions (in mm)				Weight (kg)	
	Variable speed (rpm)	Power (Watts)	Voltage* (Amp.)	A	B	C	D	net	gross
<b>Mini MP 160 V.V.</b>	2,000 to 12,500	220	230 V/50Hz - 1.1	78	430	65	160	1.41	1.94
<b>Mini MP 190 V.V.</b>	2,000 to 12,500	250	230 V/50Hz - 1.3	78	470	65	190	1.5	1.97
<b>Mini MP 240 V.V.</b>	2,000 to 12,500	270	230 V/50Hz - 1.5	78	520	65	240	1.5	2.00

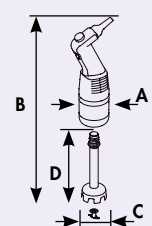

COMPACT RANGE	Electrical data			Dimensions (in mm)				Weight (kg)	
	Variable speed (rpm)	Power (Watts)	Voltage* (Amp.)	A	B	C	D	net	gross
<b>CMP 250 V.V.</b>	2,300 to 9,600	270	230 V/50 Hz 1.1	94	610	90	255	3.0	4.7
<b>CMP 300 V.V.</b>	2,300 to 9,600	300	230 V/50 Hz 1.2	94	660	90	305	3.1	4.8
<b>CMP 350 V.V.</b>	2,300 to 9,600	350	230 V/50 Hz 1.4	94	718	90	363	3.3	5.0

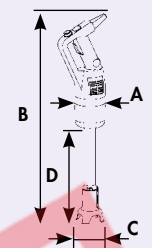

LARGE RANGE	Electrical data				Dimensions (in mm)						Weight (kg)	
	Speed (rpm)		Power (Watts)	Voltage* (Amp.)	A	B	C	D	E	F	net	gross
	Mixer	Mixer Variable speed										
<b>MP 350 Ultra</b>	9,500		440	230 V/50 Hz 2.1	125	725	100	360			4.6	6.1
<b>MP 350 V.V. Ultra</b>		1,500 to 9,000	440	230 V/50 Hz 2.1	125	725	100	360	440	120	4.8	6.3
<b>MP 450 Ultra</b>	9,500		500	230 V/50 Hz 2.3	125	825	100	460			4.9	6.4
<b>MP 450 V.V. Ultra</b>		1,500 to 9,000	500	230 V/50 Hz 2.3	125	825	100	460	440	120	5.0	6.4
<b>MP 550 Ultra</b>	9,000		750	230 V/50 Hz 3.5	125	925	111	560			5.2	6.7
<b>MP 600 Ultra</b>	9,500		850	230 V/50 Hz 3.4	124	970	110	580			5.7	7.6
<b>MP 800 Turbo</b>	9,500		1000	230 V/50 Hz 4.5	125	1,130	110	740			7.1	9

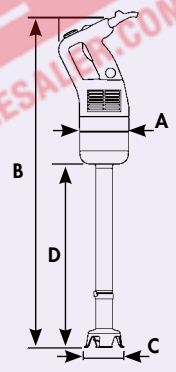

COMBI RANGE	Electrical data				Dimensions (in mm)						Weight (kg)	
	Mixer Variable speed (rpm)	Whisk Variable speed (rpm)	Power (Watts)	Voltage* (Amp.)	A	B	C	D	E	F	net	gross
<b>Mini MP 190 Combi</b>	2,000 to 12,500	350 to 1,560	250	230 V/50 Hz 1.3	78	470	65	190	255	100	1.95	2.68
<b>Mini MP 240 Combi</b>	2,000 to 12,500	350 to 1,560	270	230 V/50 Hz 1.5	78	520	65	240	255	100	1.98	2.70
<b>CMP 250 Combi</b>	2,300 to 9,600	500 to 1,800	270	230 V/50 Hz 1.1	94	610	90	255	390	120	3.0	4.7
<b>CMP 300 Combi</b>	2,300 to 9,600	500 to 1,800	300	230 V/50 Hz 1.4	94	660	90	305	390	120	3.1	4.8
<b>MP 350 Combi Ultra</b>	1,500 to 9,000	250 to 1,500	440	230 V/50 Hz 2.1	125	775	100	410	440	120	5.9	8.3
<b>MP 450 Combi Ultra</b>	1,500 to 9,000	250 to 1,500	500	230 V/50 Hz 2.3	125	875	100	510	440	120	6.1	8.5
<b>MP 450 FW Ultra</b>		250 to 1,500	500	230 V/50 Hz 2.3	125	805			440	120	4.3	6.5
<b>MP 450 XL FW Ultra</b>		250 to 1,500	500	230 V/50 Hz 2,3	150	1,175			815	175	5.3	8.5

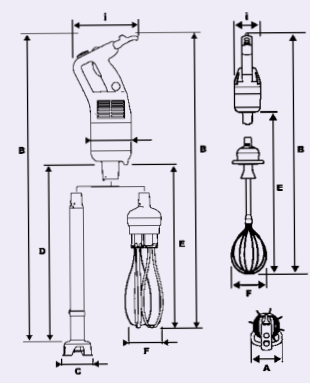

\*Other voltages available.



**HEAD OFFICE, FRENCH, EXPORT AND MARKETING DEPARTMENT:**  
 Tel.: + 33 1 43 98 88 33 - Fax: + 33 1 43 74 36 26  
 email: international@robot-coupe.com

**Robot Coupe Australia:** Tel.: (02) 9478 0300 - Fax: (02) 9460 7972  
 New Zealand: Tel.: 0800 716161 - Fax: 0800 716162  
 email: orders@robotcoupe.com.au

**Robot Coupe U.K. LTD:** Tel.: 020 8232 1800 - Fax: 020 8568 4966  
 2, Fleming Way, Isleworth, Middlesex TW7 6EU  
 email: sales@robotcoupe.co.uk

**Robot Coupe U.S.A.:** Tel.: 1-800-824-1646 - Fax: 601-898-9134  
 email: info@robotcoupeusa.com - website: www.robotcoupeusa.com

**www.robot-coupe.com**

**DISTRIBUTOR**

**STANDARDS:**

Machines in compliance with :



- The following European directives and related national legislation: 2006/42/CE, 2014/35/UE, 2014/30/UE, 2011/65/UE, 2012/19/UE, CE n° 1935/2004, UE n° 10/2011.
- The following European harmonized standards and standards setting out health and safety rules: EN ISO 12100:2010, EN 60204-1:2006, EN 60529: IP 55, IP 34, EN 12853.